



Sectional and Utility Scaffold



Sectional Scaffold



Utility Scaffold



Drywall Lifts/Carts



Handy Roll

BILJAX[®]
Haulotte 
GROUP

More than lifting

Know Your Scaffold / Safety / Decals

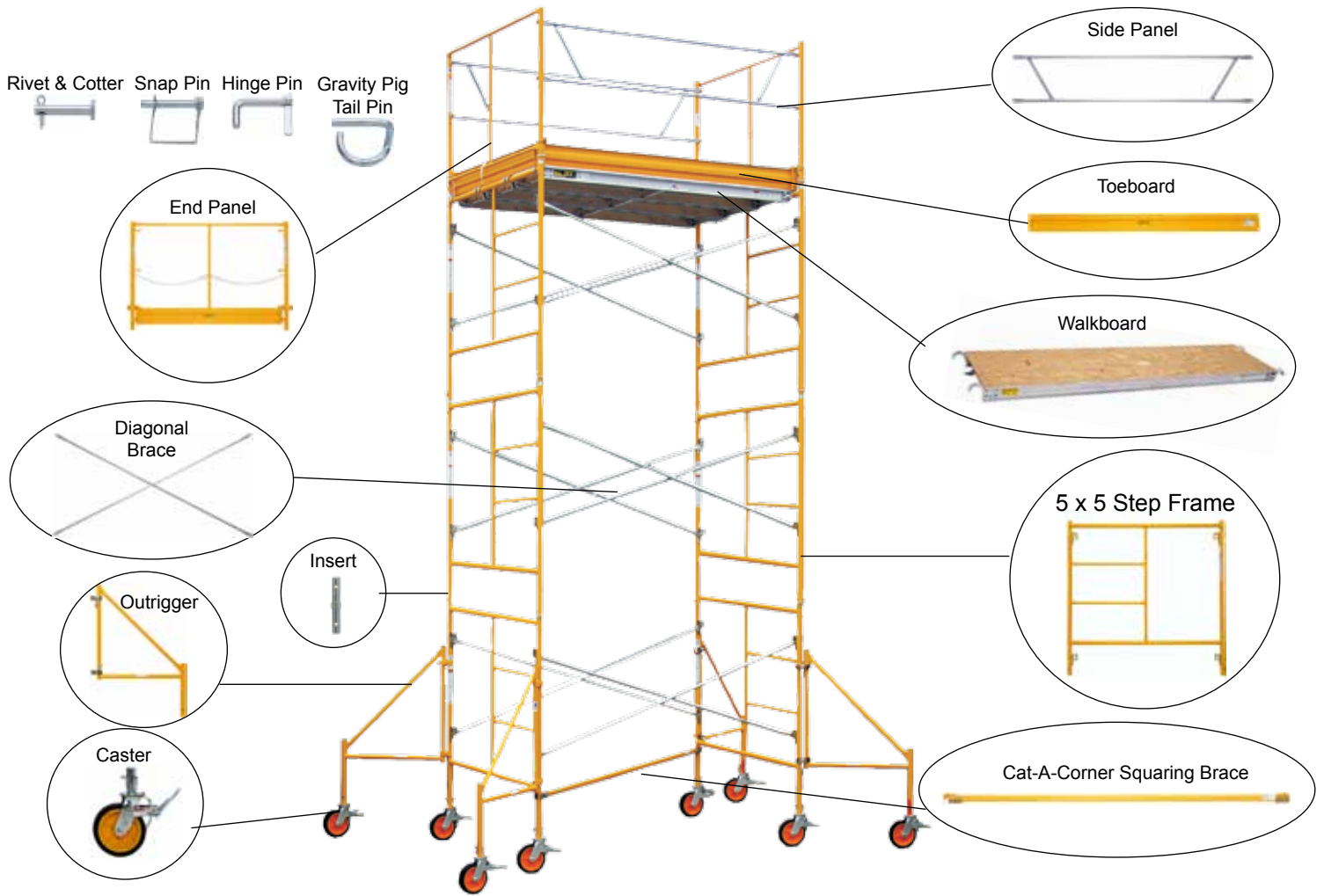

SAFETY

Part Number	Description
LL-204-22	Commitment to safety package (includes - 1 Scaffold safety video, 20 frame decals, 25 LL-204-05 scaffold safety packets, and a laminated certificate.
LL-204-01	Tips on scaffold safety / safety rule
LL-204-02	OSHA safety and health regulations for construction
LL-204-03	Recommended scaffold erection procedures
LL-204-04	Caution envelope with wire
LL-204-11	Instructions for erecting rolling towers
LL-204-05	Scaffold safety packet (includes - LL-244-01, LL-204-02, LL-204-03, LL-204-04, LL-204-11)
LL-204-27	Scaffold check guide cards

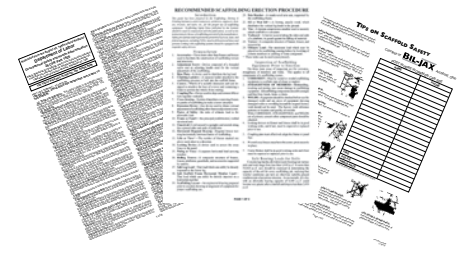

REPLACEMENT DECALS

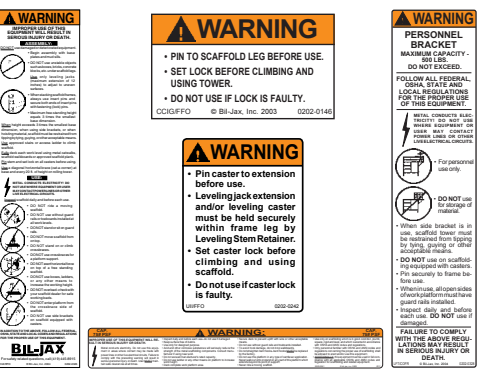

Part Number	Description
0202-0101	Panel guard caution decal
0202-0146	Caster decal (used on all BilJax casters)
0202-0242	Leveling caster / leveling jack extension decal
0202-0326	Scaffold frame caution decal
0202-0328	Personnel bracket warning decal
0202-0330	Guard railing decal
0202-0331	Walkboard / catwalk caution decal (Tuf-N-Lite)
0202-0335	Hoist arm warning decal
0202-0361	Expanded metal walkboard / catwalk decal

Frames

Frame Tube Sizes

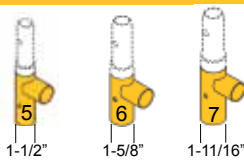

Tube Size	Description
5	Frame with 1 1/2" Leg O.D. (weighs 10% less than catalog listings)
6	Frame with 1 5/8" Leg O.D. (weighs same as catalog listings)
7	Frame with 1 11/16" O.D. (weighs 5% more than catalog listings)

Frame Lock Types

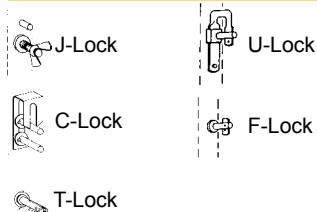

Lock Type	Description
J-Lock	J-Lock use with notched braces
C-Lock	C-Lock use with holed braces
T-Lock	T-Lock use with holed braces
U-Lock	U-Lock use with holed braces
F-Lock	F-Lock use with holed braces

STEP FRAMES - specify tube size and lock type

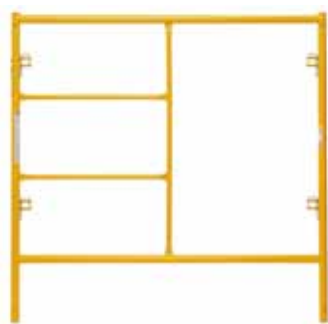

Description	Weight
5' W x 2' H Frame	23
5' W x 3' H Frame	27
5' W x 4' H Frame	33
5' W x 5' H Frame	39
5' W x 6' H Frame	45
5' W x 6' 4" H Frame	54
5' W x 6' 6" H Frame	47

Other step frames available - Contact factory

OPEN END FRAMES - specify tube size, lock type, and cane type

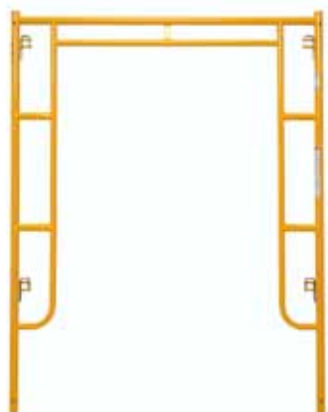

Description	Weight
3' W x 6' 4" H Frame	43
3' W x 6' 6" H Frame	40
4' W x 6' 4" H Frame	51
4' W x 6' 6" H Frame	46
5' W X 6' 4" H Frame	54
5' W x 6' 6" H Frame	50

Other open end frames available - Contact factory



Closed Cane
05

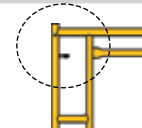

Open Cane
25

DOUBLE STEP FRAMES - specify tube size and lock type

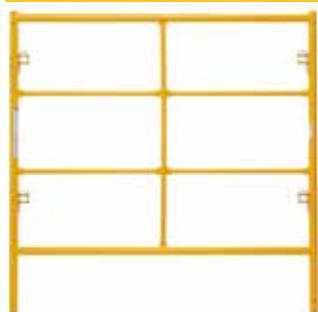

Description	Weight
5' W x 3' H Frame	27
5' W x 4' H Frame	35
5' W x 4' 6" H Frame	41
5' W x 5' H Frame	43
5' W x 6' H Frame	51
5' W x 6' 4" H Frame	54
5' W x 6' 6" H Frame	53

Other double step frames available - Contact Factory

Frames (cont.) / Rolling Tower Packages

LADDER FRAMES - specify tube size and lock type



Description	Weight	Description	Weight
28" W x 3' H Frame*	16	3' W x 5' H Frame	29.5
28" W x 4' H Frame*	21	3' W x 6' H Frame	36
28" W x 5' H Frame*	26	4' W x 3' H Frame	22.5
28" W x 6' H Frame*	31	4' W x 4' H Frame	29
3' W x 3' H Frame	18.5	4' W x 5' H Frame	36
3' W x 4' H Frame	24	4' W x 6' H Frame	43

*Exact overall width measurement is needed when ordering 28" wide frames

Other ladder frames available - Contact factory

OPEN LADDER FRAMES - specify tube size and lock type (12" Rung Spacing)

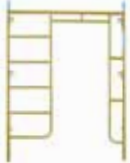

Description	Weight
5' W x 6' 4" H Frame	56
5' W x 6' 6" H Frame	57

Other open ladder frames available - Contact factory

CENTER ACCESS FRAMES - specify tube size and lock type (12" Rung Spacing)

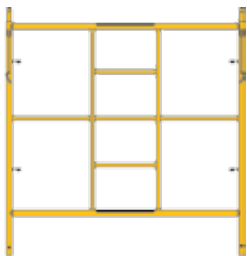

Description	Weight
5' W x 2' H Frame	24
5' W x 3' H Frame	28
5' W x 4' H Frame	34
5' W x 5' H Frame	39
5' W x 6' H Frame	55

Other center access frames available - Contact factory

SIDEWALK FRAMES - specify tube size and lock type



Description	Weight
6' W x 7' 8" H Frame furnished with Hex Lock Nut	65

Other sidewalk frames available - Contact factory

PEDESTAL SCAFFOLD FRAME - specify tube size and lock type



Description	Weight
Pedestal Scaffold Frame	37
Replacement Frame Only	17
Replacement Leg Only	10

ROLLING TOWER PACKAGES - 5' Wide - specify tube size



Part Number (5, 6, 7)z	Range	Work Ht.	Weight
7' Lengths			
ST-RU0711-(__)	2' - 11'	17'	462
ST-RU0716-(__)	2' - 16'	22'	568
ST-RU0716-(__) OR	2' - 16'	22'	664
ST-RU0716-(__) OR	2' - 21'	27'	775
ST-RU0716-(__) OR	2' - 26'	32'	881
10' Lengths			
ST-RU1011-(__)	2' - 11'	17'	542
ST-RU1018-(__)	2' - 16'	22'	660
ST-RU1016-(__) OR	2' - 16'	22'	756
ST-RU1021-(__) OR	2' - 21'	27'	876
ST-RU1026-(__) OR	2' - 26'	32'	946
ST-RU1031-(__) OR	2' - 31'	37'	1105
ST-RU1036-(__) OR	2' - 36'	42'	1220

Pin Options / Fastening Pins / Braces

INSERT PINS - specify tube size

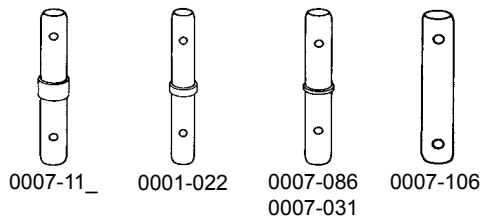

Part Number (5, 6, 7)	Description	Weight
0007-11__	9" Pin with 1" collar (fits tube size 5)	90/ct
0007-022	9" Pin with 1/2" collar (fits tube size 6)	90/ct
0007-086	9" Pin with 1/8" collar (fits tube size 5)	70/ct
0007-031	9" Pin with 1/8" collar (fits tube size 6)	90/ct
0007-106	7" Pin without collar (fits tube size 6)	60/ct
0007-134	9" Pin with special collar (fits tube sizes 6, 7)	100/ct

INSERT ATTACHMENT OPTIONS - specify tube size

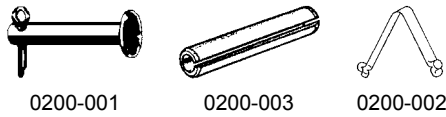

Part Number (5, 6, 7)	Description	Weight
0200-001	Rivet and cotter attachment	
0200-002	Spring rivet attachment	
0200-003__	Drive pin attachment	

FASTENING PINS

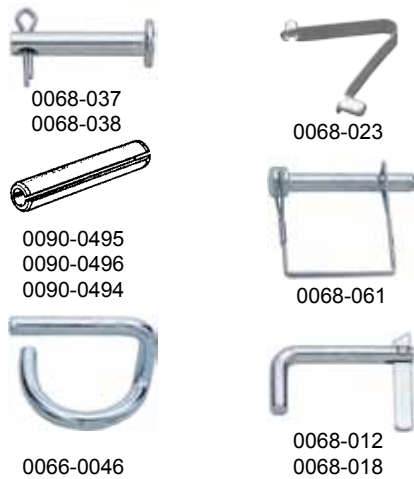

Part Number	Description	Weight
0068-037-50	2" Rivet pin with cotter	4
0068-038-50	3" Rivet pin with cotter	5
0090-0496-50	Drive pin for permanent attachment (tube size 6)	2
0090-0494-50	Drive pin for permanent attachment (tube size 7)	2
0068-023-50	Spring rivet	2
006-0046-50	2" Gravity pig tail pin	9.1
0068-061-50	2" Snap pin	6
0068-100-50	2 1/2" Snap pin	8
0068-102-50	4 1/2" Snap pin	10
0068-012-50	2" Hinge pin	5
0068-018-50	3" Hinge pin	6.6

CAT-A-CORNER SQUARING BRACES - specify tube size



Part Number (5, 6, 7)	Description	Weight
0019-4__-507	Squaring brace for a 5' wide x 7' long tower	16
0019-4__-508	Squaring brace for a 5' wide x 8' long tower	18
0019-4__-510	Squaring brace for a 5' wide x 10' long tower	20

Other Cat-A-Corner squaring braces available. Contact Factory

GALVANIZED DIAGONAL BRACES - specify end type and lock spacing

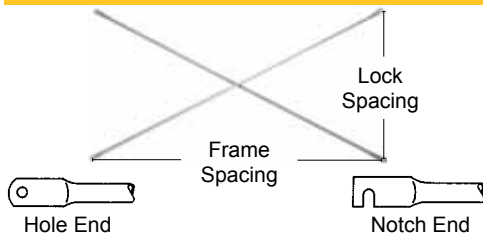

Description	Weight
5' Brace	9
7' Brace	12
8' Brace	14
10' Brace	17
Other diagonal braces available. Contact Factory	

DOUBLE HOLE GALVANIZED DIAGONAL BRACES - 36" & 48" lock spacing

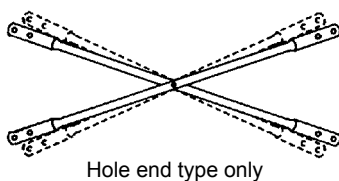

Hole end type only

Part Number	Description	Weight
0010-34-07	7' Spacing brace	12
0010-34-08	8' Spacing brace	14
0010-34-10	10' Spacing brace	17

Other diagonal braces available. Contact Factory

Braces / Leveling Jacks / Base Plates / Guard Rails

ARM BRACES - 27 3/4" lock spacing

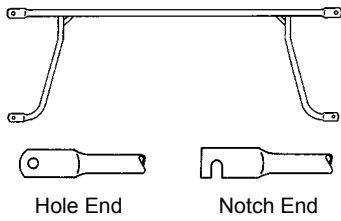

Part Number	Description	Weight
0013-15-07	7' spacing brace - hole end	15
0013-15-08	8' spacing brace - hole end	16
0013-15-10	10' spacing brace - hole end	19
0013-03-07	7' spacing brace - notch end	15
0013-03-10	10' spacing brace - notch end	19

Other arm braces available. Contact Factory

LEVELING JACKS - specify tube size



Part Number (5, 6, 7)	Description	Weight
0032-08__*	Rigid jack 24" stem with 15" adjustment	10.2
0032-09__*	Swivel jack 24" stem with 15" adjustment	12
0034-08__	Extension 15" adjustment with retainer kit	11.5
0069-0071	Leveling stem retainer	1
0032-085pl	Plated rigid jack 24" stem with 15" adjustment	10.5
0032-086pl	Plated swivel jack 24" stem with 15" adjustment	12.5

Other leveling jacks available. Contact Factory *To fit tube sizes 6 and 7, select 6 in the part number

BASE PLATES / RUBBER PAD - specify tube size

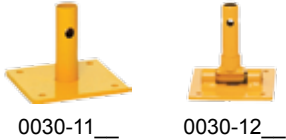

Part Number (5, 6, 7)	Description	Weight
0030-11__	Rigid base plate - 4" stem	3
0030-12__	Swivel base plate - 4" stem	4
0082-0740	Rubber pad for base plate	.5

CASTERS - specify tube size



Part Number (5, 6, 7)	Description	Weight
0026-7__2	8" wheel size - 4" stem size - 500 lb capacity (cast iron)	13
0026-9__2	8" wheel size - 4" stem size - 500 lb capacity (plastic)	9

GUARD RAIL POSTS - specify tube size

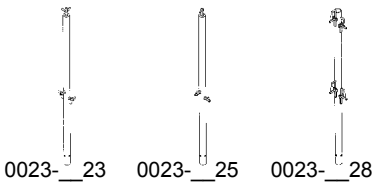

Part Number (5, 6, 7)	Description	Weight
0023-__23	Corner guard rail post - B-lock	5.7
0023-__25	Corner guard rail post - F-lock	5.5
0023-__18	Guard rail post - U-lock	5.5
0023-__28	Corner guard rail post - U-lock	5.5

GUARD RAILS - GALVANIZED



Part Number	Description	Weight
0022-02-28	End rail - 28" spacing	3
0022-01-03	End rail - 36" spacing	3
0022-02-04	End rail - 46 1/2" spacing (fits tube size 5)	3
0022-01-04	End rail - 48" spacing (fits tube sizes 6, 7)	3
0022-02-05	End rail - 58 1/2" spacing (fits tube size 5)	4
0022-01-05	End rail - 60" spacing (fits tube sizes 6, 7)	4
0022-01-07	Side rail - 7' spacing	5.25
0022-01-08	Side rail - 8' spacing	6.5
0022-25-10	Side rail - 10' spacing	8

Other side guard rail sizes available. Contact factory

Guard Rails / Toeboards / Easi-Guard System / Walkboards

INTERMEDIATE GUARD RAIL FOR OPEN END TYPE FRAMES

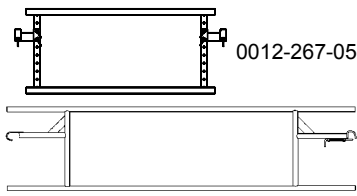

Part Number	Description	Weight
0012-263-07	7' Intermediate side guard rail panel	21
0012-263-08	8' Intermediate side guard rail panel	23
0012-263-10	10' Intermediate side guard rail panel	27
0012-267-05	5' Wide Intermediate end guard rail panel	21.5
Other intermediate guard rail panel sizes available		

6" STEEL TOEBOARDS

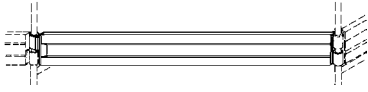

Part Number	Description	Weight
0012-016-03	End toeboard 26 5/8" (fits tube sizes 5,6)	4
0012-016-04	End toeboard 26 5/16" (fits tube size 7)	4
0012-016-05	End toeboard 36" (fits tube sizes 5, 6, 7)	5
0012-016-06	End toeboard 46 1/2" (fits tube size 5)	6
0012-012-07	End toeboard 48" (fits tube sizes 6, 7)	6
0012-016-08	End toeboard 58 1/2" (fits tube size 5)	7
0012-016-09	End toeboard 60" (fits tube sizes 6, 7)	7.8
0012-016-12	Side toeboard 7' (fits tube sizes 5, 6, 7)	9
0012-016-14	Side toeboard 8' (fits tube sizes 5, 6, 7)	10
0012-016-18	Side toeboard 10' fits tube sizes (5, 6, 7)	12

TOEBOARD CLIPS

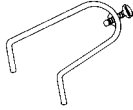

Part Number	Description	Weight
0063-0199	Toeboard clip	.5
0063-0203	Corner toeboard bracket	.5

EASI-GUARD SYSTEM - specify tube size

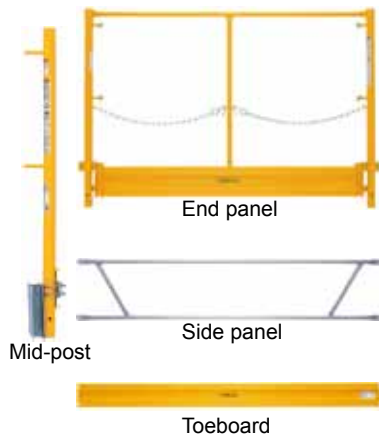

Part Number (5, 6, 7)	Description	Weight
0012-23__	Mid-post	9
0012-22__-28	End panel 28" with toeboard	14
0012-22__-03	End panel 36" with toeboard	17
0012-22__-04	End panel 48" with toeboard	21
0012-22__-05	End panel 60" with toeboard	34
0012-209-07	Side panel 7'	12
0012-209-08	Side panel 8'	14
0012-210-10	Side panel 10'	17
0012-202-07	Side toeboard 7' steel	8
0012-202-08	Side toeboard 8' steel	10
0012-202-10	Side toeboard 10' steel	14.5

SWING GATE

Part Number	Description	Weight
0253-35	Swing gate for 5' wide open end frames	22

X-PANDED STEEL WALKBOARD - STEEL FRAME WITH EXPANDED STEEL DECK



Part Number	Description	Weight
0044-205	19" Wide x 7' long - 75 psf capacity	45
0044-225	24" Wide x 7' long - 75 psf capacity	52
0044-227	24" Wide x 8' long - 75 psf capacity	58
0044-235	28" Wide x 7' long - 75 psf capacity	56
0044-237	28" Wide x 8' long - 75 psf capacity	64
0044-245	32" Wide x 7' long - 75 psf capacity	62

Other side guard rail sizes available. Contact factory

Walkboards

TUF-N-LITE WALKBOARD ALUMINUM FRAME WITH PLYWOOD DECK

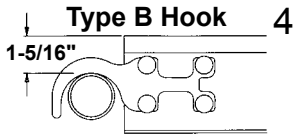
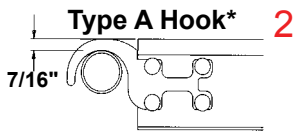

Type A part numbers listed. For Type B replace red 2 with a 4 in the part number

Part Number	Description	Weight
0054-216	19' Wide x 7' long - 75 psf capacity	32
0054-220-50	19' Wide x 10' long - 50 psf capacity	40
0054-220	19' Wide x 10' long - 75 psf capacity	46.5
0054-226	22' Wide x 7' long - 75 psf capacity	35
0054-230	22' Wide x 10' long - 50 psf capacity	44.5
0054-236	24' Wide x 7' long - 75 psf capacity	37
0054-240	24' Wide x 10' long - 50 psf capacity	50
0054-246	28' Wide x 7' long - 75 psf capacity	39
0054-250	28' Wide x 10' long - 50 psf capacity	54
0054-256	32' Wide x 7' long - 50 psf capacity	47

Other Tuf-N-Lite walkboard sizes available. Contact factory.

TUF-N-LITE WALKBOARD REPLACEMENT PARTS

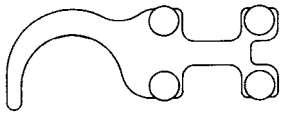

Aluminum hook replacement kit



Plywood deck replacement

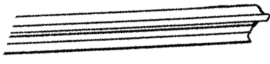

Aluminum cross member

Part Number	Description	Part Number	Description
0054-007-07	7' Aluminum rail 4 mem / punch	0090-0545	1/4 - 20 x 1S / tap screw
0054-002-07	7' Aluminum rail 3 mem / punch	0090-0987	3/16 drive rivet
0054-007-08	8' Aluminum rail 4 mem / punch	0191-0019	Plywood for 0054-216
0054-002-08	8' Aluminum rail 3 mem / punch	0191-0022	Plywood for 0054-220
0054-009-10	10' Aluminum rail 4 mem / punch	0191-0049	Plywood for 0054-248
0054-102	Lock - swivel assembly, heavy duty A	0191-0050	Plywood for 0054-250
0054-101	Lock - swivel assembly, heavy duty B	0054-080	Conversion kit 2-bolt to 4 bolt
0054-130	Aluminum hook type A replacement kit		
0054-131	Aluminum hook type B replacement kit		
0054-018-05	Aluminum cross member for 19 walkboard		
0054-018-08	Aluminum cross member for 28 walkboard		
0054-018-09	Aluminum cross member for 32 walkboard		

Other Tuf-N-Lite replacement parts available. Contact factory.

X-TRU-LITE WALKBOARD 7100 SERIES - ALUMINUM FRAME AND DECK



Part Number	Description	Weight
0055-216	19 1/4" Wide x 7' long - 75 psf capacity	32
0055-220	19 1/4" Wide x 10' long - 75 psf capacity	40

Other X-Tru-Lite walkboard sizes available. Contact factory.

X-TRU-LITE WALKBOARD REPLACEMENT PARTS

Part Number	Description	Weight
0055-216-3	End Support / 19" X-Tru-Lite	1
0082-0553	Aluminum hook repair kit - 1 hole	4

OUTRIGGER - specify tube size (5, 6, 7)



Part Number (5, 6, 7)	Description	Weight
0048-2__	30" wide outrigger	14

Brackets / Hoist Arm / Outrigger / Putlogs

SIDE AND END BRACKETS - specify tube size

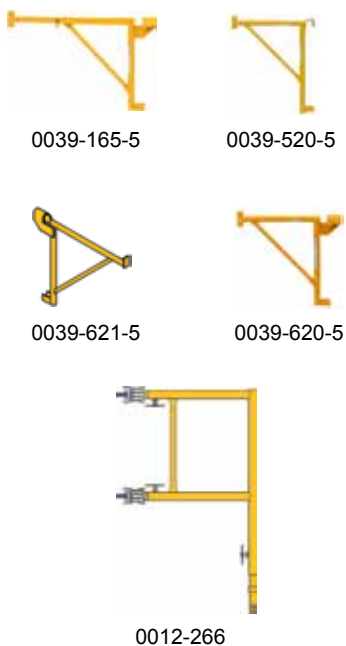

Part Number	Description	Capacity	Weight
SIDE BRACKETS			
0039-620-__	20" Saddle hanger with tube end	500 lb	9
0039-624-__	24" Saddle hanger with tube end	500 lb	10
0039-630-__	30" Saddle hanger with tube end	500 lb	13
0039-165-__	20" - 30" Adjustable saddle hanger with tube end	500 lb	14
0039-124	12" Saddle hanger with plate end	500 lb	6
0039-621	21" Saddle hanger with plate end	500 lb	9
0039-720-__	20" Angle iron hanger - side hang-on with tube end	500 lb	9
0039-724-__	24" Angle iron hanger - side hang-on with tube end	500 lb	11.5
0039-730-__	30" Angle iron hanger - side hang-on with tube end	500 lb	13
0039-171-__	20" - 30" Adjustable angle iron hanger with tube end	500 lb	14
END BRACKETS			
0039-520-__	20" End and side hang-on with tube end	500 lb	10.5
0039-524-__	24" End and side hang-on with tube end	500 lb	13
0039-530-__	30" End and side hang-on with tube end	500 lb	14
END GUARD RAIL FOR SIDE BRACKET			
0012-266	End guard rail for 20" to 30" side bracket		19

HOIST ARM - WELL WHEEL - TIE BRACE

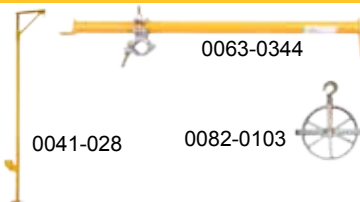

Part Number	Description	Weight
0041-028	Swivel head hoist arm	29
0082-0103	10" Well wheel	9.3
0063-0344	Scaffold tie brace	11

PUTLOGS

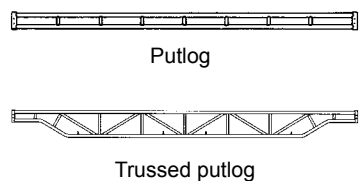

Part Number	Description	Weight	Part Number	Description	Weight
0036-178	8' Putlog	24	0036-602	18' Putlog - trussed	79
0036-180	10' putlog	30	0036-603	20' Putlog - trussed	92
0036-182	12' Putlog	36	0036-604	22' Putlog - trussed	101
0036-600	14' Putlog - trussed	47	0036-605	24' Putlog - trussed	111
0036-601	16' Putlog - trussed	70	0036-606	26' Putlog - trussed	118

Other putlog sizes available. Contact factory.

PUTLOG ACCESSORIES

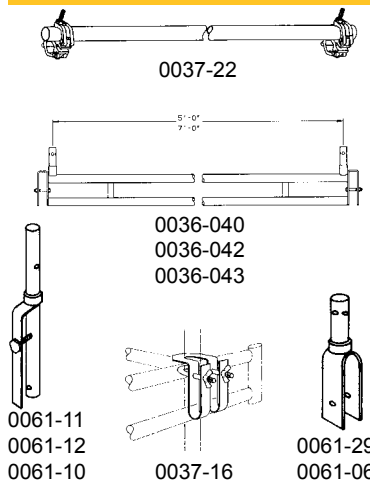

Part Number	Description	Weight
0037-16	Putlog angle hanger	3.5
0061-11	Offset insert saddle (tube size 5)	3
0061-12	Offset insert saddle (tube size 6)	3
0061-10	Offset insert saddle (tube size 7)	3
0061-29	Insert saddle (tube size 5)	3
0061-06	Insert saddle (tube size 6)	3
0061-23	Insert saddle (tube size 7)	3
0037-22	Putlog support 8' long with clamps	20
0036-040	Putlog spreader - 5' frame sp (tube size 6)	24
0036-042	Putlog spreader - 5' frame sp (tube size 5)	14
0036-043	Putlog spreader - 7' frame sp (tube size 5)	24

Other putlog accessories available. Contract factory.

Clamps / Brackets / Replacement Parts / Stair Tower Components

DROPPED FORGED CLAMPS

Part Number	Description	Weight
0069-0094 0069-0117	Swivel clamp with "Eye" bolt - fits 1.625", 1.69", 1.9" tube diameter	3
0069-0094	Rigid clamp with "Eye" bolt - fits 1.625", 1.69", 1.9" tube diameter	3
0069-0118	Swivel clamp with "Eye" bolt - fits 1.69" and 1.9" tube diameter	3
0069-0117	Rigid clamp with "Eye" bolt - fits 1.69" and 1.9" tube diameter	3

BRACKETS AND CLAMPS

Part Number	Description	Weight
0069-0017	Parallel tube clamp	1.5
0069-0016	Bracket for hole or notched brace	.5
0069-0026	Bracket for hole brace	.5
0069-0013	Clamp for notched brace	1.5
0069-0043	Clamp for hole brace	1.5
0069-0070	B-Lock clamp (tube size 5)	.5
0069-0057	B-Lock clamp (tube size 6, 7)	.5

REPLACEMENT PARTS

Part Number	Description	Part Number	Description
0064-0783	Half outrigger clamp	0068-004	Lever tail nut 5" long
0066-0006	Putlog clamp hook	0068-008	Brace rivet with 3 washers
0067-0005	Gooser brace slide	0068-042/1	Package 50 brace rivets with 150 washers
0067-0039	Leveling nut (1 7/16")	0068-042/50	Package 50 brace rivets with 150 washers
0067-0046	Leveling nut (1 1/4")	0068-095	U-Bolt only - Putlog angle hanger 0037-18
0068-004	1/2" set screw	0090-0517	Thumb screw - 3/8" diameter x 1 1/4" long

BRACE LOCK PARTS

Part Number	Description	Part Number	Description
0064-0604	C-Lock with stud pin	0008-042	F-Lock complete
0068-009	C-Lock stud	0008-048	U-Lock complete
0068-013	C-Lock slide	0068-009	J-Lock stud 1/2"
0008-022-4/50	C-Lock washer	0066-0044	J-Lock pin 3/8" x 3/4"
0090-0311/50	C-Lock roll pin	0068-013	J-Lock wing nut 1/2"
0008-044	T-Lock complete		

TUF-N-LITE HINGED LADDER BOARD - ALUMINUM FRAME, PLYWOOD DECK, ATTACHED LADDER

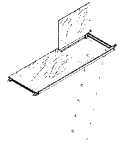

Part Number	Description	Weight
0054-125-07	28" Wide x 7' long - 75 psf capacity	69
0054-125-08	28" Wide x 8' long - 50 psf capacity	75
0054-125-10	28" Wide x 10' long - 50 psf capacity	81

STAIR TOWER COMPONENTS

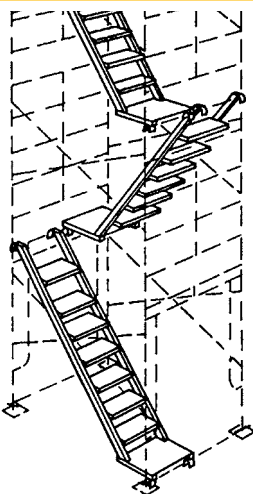

Part Number	Description	Part Number	Description
0042-019	Stair platform rest (tube size 5)	0043-185	Outside handrail (top section)
0042-027	Stair platform rest (tube size 6)	0042-175	Inside handrail (top section)
0042-035	Stair platform rest (tube size 7)	0042-221	24" Wide stair section 6' 5"
0042-047	Open frame safety guard	0042-022	24" Wide stair section 6' 6"
0042-094	Outside handrail	0042-223	24" wide stair section 6' 7"
0042-093	Inside handrail		
0044-052	Intermediate catwalk 28" wide x 7' long with guardrail		
0044-054	Hinged platform 28" wide x 7' long expanded steel		
0044-235	28" Wide x 7' Long expanded steel catwalk - 75 psf capacity		

BilJax offers a heavy duty stair tower for worker access to buildings, bridges, observation towers, or renovation done inside or outside. The stairs can also be used for access in a scaffold set-up.

Access Ladder / Climbing Ladder

ACCESS LADDER SYSTEM (see below image)

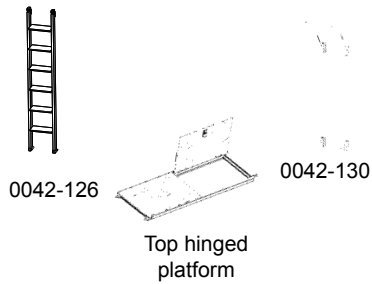

Part Number	Description	Weight
0042-126	6' Access ladder (use with 6' 6" high frame)	37
0042-130	6' Handrails (pair)	10.5
0042-129	Platform rest (tube size 5) (2 required at 1st tier only)	7.5
0042-128	Platform rest (tube size 6, 7) (2 Required at 1st tier only)	8
0054-346	Top hinged platform 28" x 7'	43
0054-348	Top hinged platform 28" x 8'	49
0054-350	Top hinged platform 28" x 10'	55

CLIMBING LADDER - TUBULAR TYPE (see below image)

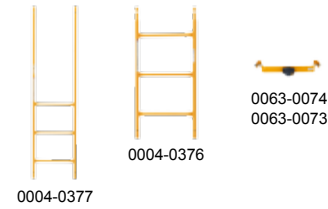

Part Number	Description	Weight
0004-0377	6' Top section	19
0004-0375	6' Ladder section	17.5
0004-0376	3' Ladder section	9.2
0063-0074	Support bracket (tube size 5)	5.5
0063-0073	Support bracket (tube size 6, 7)	5.5

CANOPY TOP / WEATHER PROTECTION CLIP (see below image)

Part Number	Description	Weight
0071-021	Canopy top with adjustable extension - 5' W x 1' H (tube size 6)	27
0071-022	Canopy Top with adjustable extension - 5' W x 1' H (tube size 7)	27
0071-024	Canopy top with adjustable extension - 5' W x 1' H (tube size 5)	27
0082-0228	Weather protection clips 8" L 9 (qty. 100)	16

ADDITIONAL ILLUSTRATIONS

ACCESS LADDER SYSTEM

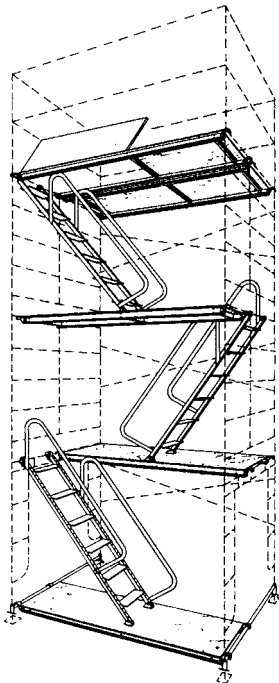

CLIMBING LADDER
TUBULAR TYPE

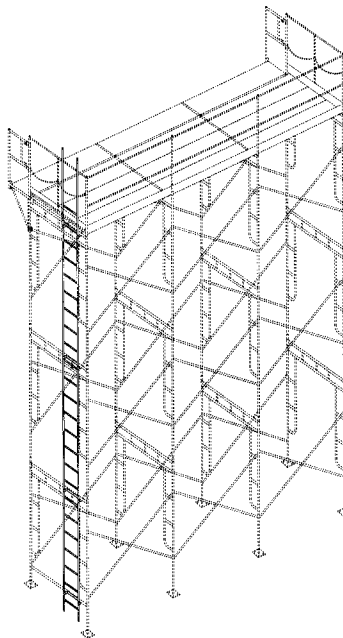

CANOPY TOP
WEATHER PROTECTION CLIP

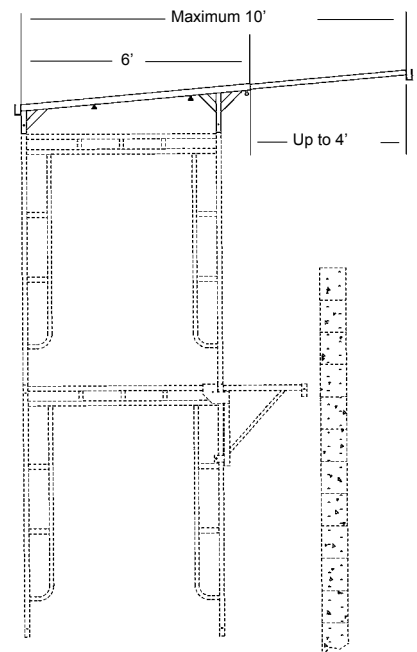

Pro-Jax Scaffold Packages / Guard Rail

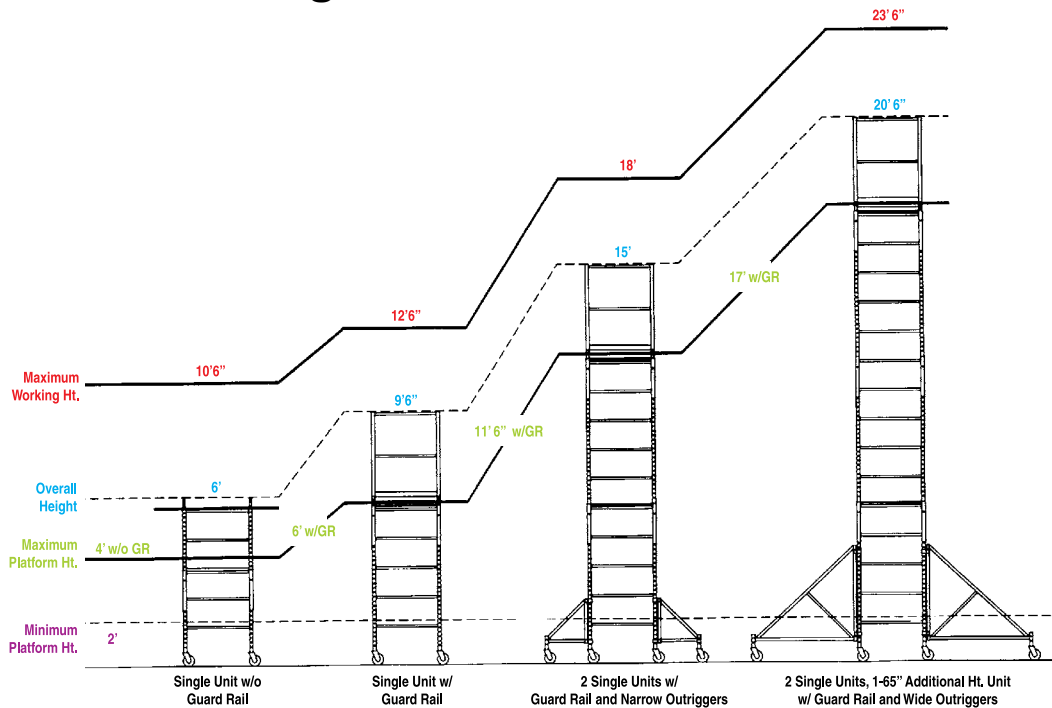

PRO-JAX UTILITY SCAFFOLD PACKAGES WITH PLYWOOD DECK WALKBOARDS



Part Number	Description		Includes		Weight
	Length	Platform Ht Range	Guard Rails	Outriggers	
0127-006-0	6'	2' - 4'	No	No	147
0127-006-1	6'	2' - 6'	Yes	No	240
0127-006-2	6'	2' - 11.5'	Yes	Yes	430
0127-006-3	6'	2' - 17'	Yes	Yes	538
0127-008-0	8'	2' - 4'	No	No	173
0127-008-1	8'	2' - 6'	Yes	No	279
0127-008-2	8'	2' - 11.5'	Yes	Yes	490
0127-008-3	8'	2' - 17'	Yes	Yes	609
0127-010-0	10'	2' - 4'	No	No	200
0127-010-1	10'	2' - 6'	Yes	No	316
0127-010-2	10'	2' - 11.5'	Yes	Yes	525
0127-010-3	10'	2' - 17'	Yes	Yes	645

PRO-JAX UTILITY SCAFFOLD ADDITIONAL HEIGHT PACKAGES



Part Number	Description	Weight
0127-007-3	6' Length x 39" height unit	75
0127-007-5	6' Length x 65" height unit	95
0127-009-3	8' Length x 39" height unit	93
0127-009-5	8' Length x 65" height unit	103
0127-011-3	10' Length x 39" height unit	97
0127-011-5	10' Length x 65" height unit	123

PRO-JAX GUARD RAIL PACKAGES, OUTRIGGER PACKAGES, AND LEVELING EXTENSION



Part Number	Description	Weight
0127-149-06	6' Complete guard rail package (2 pieces)	81.5
0127-149-08	8' Complete guard rail package (2 pieces)	98
0127-149-10	10' Complete guard rail package (2 pieces)	115
0127-150-18	18" Wide outrigger package (4 pieces)	39
0127-150-24	24" Wide outrigger package (4 pieces)	44
0127-138	Leveling extension	

Pro-Jax Replacement Parts & Components / Handy Roll

PRO-JAX REPLACEMENT PARTS

Part Number	Description	Weight
0063-0377	L-Pin replacement kit for platform arm brace	.25
0063-0418	Wind latch replacement kit	.25
0063-0605	Saf-T-Lok replacement kit	.40

PRO-JAX COMPONENTS

Part Number	Description	Weight
0127-102	39" High ladder frame	15
0127-101	65" ladder frame	25
0127-147	Base extension unit	29
0127-163-06	6' Platform arm brace	21
0127-163-08	8' Platform arm brace	26
0127-163-10	10' Platform arm brace	32
0127-108-06	6' Plywood deck	29
0127-108-08	8' Plywood deck	40
0127-108-10	10' Plywood deck	52
0127-141-06	6' Top hinged plywood deck	47
0127-141-08	8' Top hinged plywood deck	60
0127-141-10	10' Top hinged plywood deck	73
0127-113	6' Expanded metal deck	36
0127-114	8' Expanded metal deck	48
0127-115	10' Expanded metal deck	60
0127-106-06	6' Combination guard panel	35.5
0127-106-08	8' Combination guard panel	42
0127-106-10	10' Combination guard panel	48
0127-105-18	18" Wide outrigger	8
0127-105-24	24" Wide outrigger	11
0127-118	48" Wide outrigger	26
0127-136-06	6' Intermediate guard rail	20
0127-136-08	8' Intermediate guard rail	24
0127-136-10	10' Intermediate guard rail	28
0127-138	Adjustable leg with rubber pad	3
0026-835	5" Caster - 250 lb capacity with 2" snap pin (trailing edge brake lock)	4.75
0026-952	8" Caster - 500 lb capacity with 2" snap pin - P5	10



0127-102



0127-101



0127-108-06



0127-113



0127-149-06

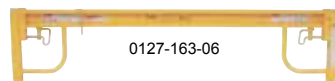

0127-163-06



0127-150-18



0026-835



0026-952

HANDY ROLL SCAFFOLDING 4-CASTER UNITS

Part Number	Description	Weight
0063-0435-34	3' Handy roll scaffold 4-caster unit with steel platforms - 24" wide x 48" long x 39" high	82
0063-0435-44	4' Handy roll scaffold 4-caster unit with steel platforms - 24" wide x 48" long x 51" high	87
0063-0435-54	5' Handy roll scaffold 4-caster unit with steel platforms - 27" wide x 64" long x 63" high	106



Drywall Cart / Drywall Lift

DRYWALL CART

0063-0575-11YE



Part Number	Description	Capacity	Weight
0063-0573-01YE	Model DC 3000 LD, light duty with plastic casters (2 swivel - 2 rigid) - 23" wide x 50" long x 47" high	3000	84
0063-0574-11YE	Model DC 3000 MD, medium duty with steel casters (2 swivel - 2 rigid) - 23" wide x 49" long x 47" high	3000	104
0063-0575-11YE	Model DC 3000 EX, heavy duty with steel casters (2 swivel - 2 rigid) - 28" wide x 50" long x 47" high	3000	137

DRYWALL LIFT

0063-0580



Part Number	Description	Capacity	Weight
0063-0547	Model DL 100 Steel - 5' to 10' lift adjustment	200	104
0063-0580	Model DL 125 Steel - 5' to 12' lift adjustment	200	125
0063-0595	Model DL 150 Steel - 5' to 15' lift adjustment	160	141

Scaffold Safety Guidelines - recommended by Scaffolding, Shoring & Forming Institute

It shall be the responsibility of all employers and employees to read and comply with the following common sense guidelines which are designed to promote safety in the erecting and dismantling of scaffolds. These guidelines do not purport to be all-inclusive nor to supplant or replace other additional safety and precautionary measures to cover usual or unusual conditions. Local, State or Federal statute or regulations shall supersede these guidelines if there is a conflict and it is the responsibility of each employee to comply.

GENERAL GUIDELINES

- I. POST THESE SCAFFOLDING SAFETY GUIDELINES in a conspicuous place and be sure that all persons who erect, dismantle or use scaffolding are aware of them.
- II. FOLLOW ALL STATE, LOCAL AND FEDERAL CODES, ORDINANCES AND REGULATIONS pertaining to scaffolding because they may be more restrictive. For example, height or width requirements may vary.
- III. SURVEY THE JOB SITE—A survey shall be made of the job site for hazards, such as untamped earth fills, ditches, debris, high tension wires, unguarded openings, and other hazardous conditions created by other trades. These conditions shall be corrected or avoided as noted in the following sections.
- IV. INSPECT ALL EQUIPMENT BEFORE USING—Never use any equipment that is damaged or defective in any way.
- V. KEEP ALL EQUIPMENT IN GOOD REPAIR—Avoid using corroded equipment—the strength of corroded equipment is not known.
- VI. INSPECT ERECTED SCAFFOLDS DAILY—or at the beginning of every shift to be sure that they are maintained in safe condition.
- VII. NEVER USE EQUIPMENT FOR PURPOSES OR IN WAYS FOR WHICH IT WAS NOT INTENDED.
- VIII. REPORT ANY UNSAFE CONDITION. NEVER TAKE CHANCES—Do not work on scaffolds if your physical condition is such that you feel dizzy or unsteady in any way.
- IX. WORKING UNDER THE INFLUENCE OF ALCOHOL OR ILLEGAL DRUGS IS STRICTLY PROHIBITED.
- X. CONSULT YOUR SCAFFOLDING SUPPLIER—NEVER TAKE CHANCES—Consult manuals and instructions provided by the supplier; scaffolding is his business.

GUIDELINES FOR ERECTION AND USE OF SCAFFOLDS

- A. PROVIDE ADEQUATE SILLS for scaffold posts and use base plates.
 - B. USE ADJUSTING SCREWS or other approved conditions.
 - C. PLUMB AND LEVEL ALL SCAFFOLDS as the erection proceeds. Do not force braces to fit—the scaffold until proper fit can be made easily.
 - D. BRACING. Each frame or panel shall be braced by horizontal bracing, cross bracing, diagonal bracing or any combination thereof for securing vertical members together laterally. All brace connections shall be made secure, in accordance with manufacturers' recommendations.
 - E. DO NOT CLIMB CROSS BRACES. Use only an access (climbing) ladder, access steps, frame designed to be climbed or equivalent safe access to scaffold.
 - F. TIE RUNNING SCAFFOLD TO WALL or structure when the height exceeds* four (4) times the minimum scaffold base dimension. The first vertical and longitudinal tie shall be placed at this point. Vertical ties shall be repeated at intervals not greater than 26 feet. Longitudinal ties shall be placed at each end and at intervals not greater than 30 feet. Ties must prevent the scaffold from tipping into or away from the wall or structure.
 - G. WHEN SCAFFOLDS ARE TO BE PARTIALLY OR FULLY ENCLOSED, specific precautions must be taken to assure frequency and adequacy of ties attaching the scaffolding to the building due to increased load conditions resulting from effects of wind and weather. The scaffolding components to which the ties are attached must also be checked for additional loads.
 - H. WHEN FREE STANDING SCAFFOLD TOWERS exceed* four times their minimum base dimension vertically, they must be restrained from tipping.
 - I. DO NOT ERECT SCAFFOLDS NEAR ELECTRICAL POWER LINES UNLESS PROPER PRECAUTIONS ARE TAKEN. Consult the power service company for advice.
 - J. DO NOT USE ladders or makeshift devices on top of scaffolds to increase the height.
 - K. DO NOT EXCEED MANUFACTURERS' RECOMMENDED LOAD RATING.
 - L. EQUIP AND MAINTAIN ALL PLATFORMS with proper guardrails, midrails, and toeboards along all open sides and ends of scaffold platforms.
 - M. ALL BRACKETS shall be seated correctly with side brackets parallel to the frames and end brackets at 90 degrees to the frames. Brackets shall not be bent or twisted from normal position. Brackets (except mobile brackets designed to carry materials) are to be used as work platforms only and shall not be used for storage of material or equipment. When brackets are used, the scaffold shall be tied to the structure or otherwise restrained to prevent tipping.
 - N. ALL SCAFFOLDING ACCESSORIES shall be used and installed in accordance with the manufacturers' recommended procedure. Accessories shall not be altered in the field. Scaffolds, frames and their components of various manufacturers shall not be intermixed.
- O. FOR PLANKING, THE FOLLOWING GUIDELINES APPLY:
 1. Use only lumber that is properly inspected and graded as scaffold plank.
 2. Planking shall have at least 12 inches of overlap and extend 6 inches beyond center of support, or, be cleated at both ends to prevent sliding off supports.
 3. Fabricated scaffold planks and platforms, unless created or restrained by hooks, shall extend over their end supports not less than 6 inches nor more than 12 inches.
 4. Secure plank to scaffold when necessary.
- P. FOR ROLLING SCAFFOLDS THE FOLLOWING ADDITIONAL GUIDELINES APPLY.
 1. CASTERS WITH PLAIN STEMS shall be attached to the panel or adjustment screw by pins or other suitable means.
 2. DO NOT EXTEND ADJUSTING SCREWS ON ROLLING SCAFFOLDS MORE THAN 12 INCHES.
 3. WHEELS OR CASTERS shall be provided with a locking device and kept locked during erection and dismantling or any time scaffolds are not being moved.
 4. SECURE OR REMOVE ALL MATERIAL AND EQUIPMENT from platform before moving scaffold.
 5. USE HORIZONTAL DIAGONAL BRACING near the bottom and at 20 foot intervals measured from the rolling surface.
 6. DO NOT USE brackets or other platform extensions without consideration of overturning effect.
 7. THE HEIGHT OF A ROLLING SCAFFOLD excluding its uppermost guardrails, must not exceed* four times its smallest base dimension unless it is stabilized by an engineered counterweight system or some other equivalent means.
 8. CLEAT OR SECURE ALL PLANKS.
 9. DO NOT ATTEMPT TO MOVE A ROLLING SCAFFOLD WITHOUT SUFFICIENT HELP—watch out for holes in floor and overhead obstructions—stabilize against tipping.
 10. DO NOT RIDE ROLLING SCAFFOLDS.
 11. JOINTS shall be restrained from separation.
- Q. FOR "PUTLOGS" AND "TRUSSES" the following additional guidelines apply.
 1. DO NOT CANTILEVER OR EXTEND PUTLOGS/TRUSSES as side brackets without thorough consideration for loads to be applied.
 2. PUTLOGS/TRUSSES SHOULD BE EXTENDED AT LEAST 6 inches beyond point of support.
 3. PLACE RECOMMENDED BRACING BETWEEN PUTLOGS/TRUSSES when the span of putlog/truss is more than 12 feet.
- R. WHEN DISMANTLING SCAFFOLDING THE FOLLOWING ADDITIONAL GUIDELINES APPLY:
 1. CHECK TO SEE IF SCAFFOLDING HAS BEEN STRUCTURALLY ALTERED in any way which would make it unsafe, and if so, reconstruct where necessary before commencing with dismantling procedures.
 2. VISUALLY INSPECT PLANK prior to dismantling to be sure that they are safe to work on.
 3. COMPONENTS SHOULD BE LOWERED as soon as dismantled in safe manner so as to protect personnel below.
 4. DO NOT ACCUMULATE EXCESS COMPONENTS OR EQUIPMENT on the level being dismantled.
 5. DISMANTLED EQUIPMENT should be stockpiled in an orderly manner.
- S. FOLLOW ERECTION PROCEDURES AND USE MANUALS.



Other Offerings from Haulotte Group



SCAFFOLD FRAME MEASUREMENT CHARTS

These facts are needed whenever you are not sure that the frame is a BilJax brand product. If you do not have previous experience with the frame ordered, or if you do not have the item number, answer the below questions and provide them with your order.

Step frame

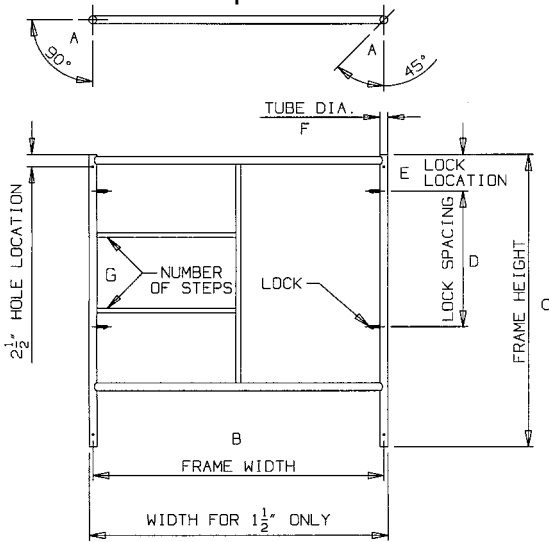

Open frame

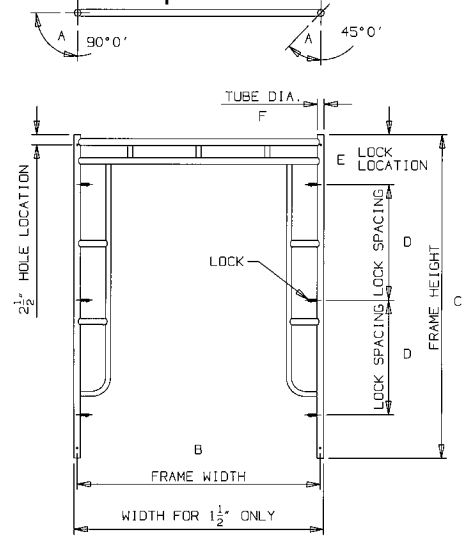

Center access frame

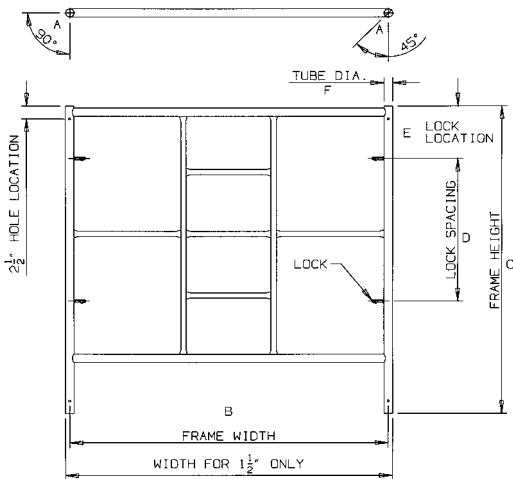

Ladder frame

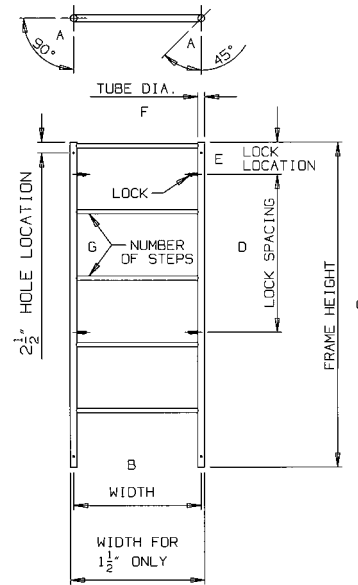

A. Specify Rotation of Pin Holes

1. 90° or 45° top & bottom

90° Standard

B. Width of Frame Center to Center

1. To get this measurement, place tape outside to inside of leg tube.

C. Frame Height

1. Measure overall top to bottom
2. DO NOT include insert (stacking pin) in measurement

D. Lock Spacing

1. Measure distance from top of top lock pin to top of bottom lock pin
2. When a lock had two pins, use the lower pin of both locks

E. Lock Location

1. Measure between top of leg and the center of the top lock pin
2. In case of a two pin lock, use the lower pin

F. Tube Size of Leg (diameter)

1. Measure leg outside to outside
- 1-1/2", 1-5/8", 1-11/16" standard sizes

